



Sola Aqua solar heating for swimming Pools

Instruction for installation and operating

Introduction

Solar heating for swimming pools with Sola Aqua-Absorbers normally will be operated with a direct circuit. The water from the pool will be pumped directly through the absorbers. You don't have to interpose a heat exchanger.

Different configurations of Sola Aqua swimming pool solar heating

1. Operation with filter pump via three-way motor ball valve with difference-temperature regulation

This configuration can usually be selected if the absorbers are not to be set up higher than 6 m above the surface of the water. The three-way motor ball valve is integrated into the pressure line of the filter installation. Because of the difference-temperature regulation the ball valve is changed over when the absorber temperature is higher than the temperature of the water of the swimming pool. The filter stream is then pumped through the absorbers. The warmed water flows back into the filter circuit by way of a Tee.

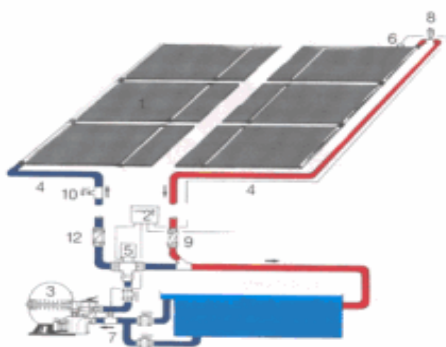

2. Operation with own pump an difference temperature regulation integrated into the filter circuit

In many cases it may be sensible or even necessary to install a separate pump for the solar heating. For example when the delivery head from the water level to the absorber panel is more than 6 m. The water is diverted from the filter installation by way of a Tee and pumped through the absorbers by the auxiliary pump. This pump is switched by the difference-temperature regulation to ensure that it only runs to actually win energy. The filter and solar pump are separately regulated. It is usually advisable to integrate non-return valves in both the solar and the filter circuit.

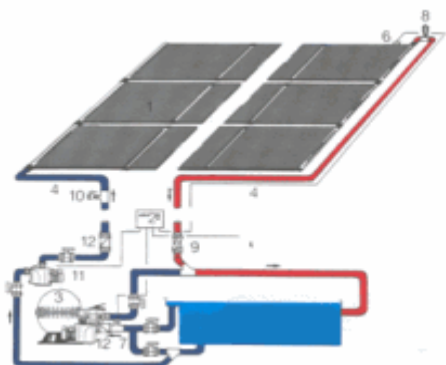

3. Operation with own pump and difference-temperature regulation - piping independent of filter circuit

This configuration is chosen when the filter piping is difficult of access. The water is sucked out of the swimming pool by an immersion pipe, pumped through the absorbers, and the warmed water is conducted back into the swimming pool. Here too the difference temperature regulation ensures that the pump only runs to win energy. If the pump is mounted above the water level and the delivery head is more than 5 m, a non-return valve should be incorporated.

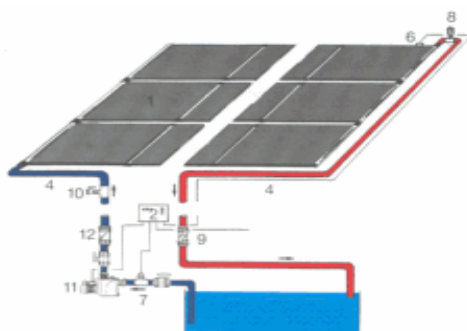

- | | | |
|---|--------------------------------------|--------------------------------|
| 1) Sola Aqua-Absorber | 5) Three-way motor ball valve | 9) Stop cock (downdraft brake) |
| 2) Difference-temperature regulation OE 1 | 6) Temperature sensor, absorbers | 10) Drain cock |
| 3) Filter installation | 7) Temperature sensor, swimming pool | 11) Pump for solar circuit |
| 4) Solar circuit forward and return | 8) Vent valve | 12) Non-return valve |

The water of the swimming pool can flow through the Sola Aqua absorbers in either direction, so they can be mounted both lengthwise and side by side. The individual rows of absorbers are connected on a Tichelmann principle (same routes for each row). It is not advisable to connect more than ten absorbers in series.

We recommend to read the following instruction thoroughly before starting the installation and to make a plan of how to connect the absorbers in case your arrangement of absorbers differs from the example shown below. This example represents a system with 16 Sola Aqua absorbers in 4 lines at 4 items. Depending on the size of your swimming pool and the area available for the absorbers numerous other schemes of installation are also possible.

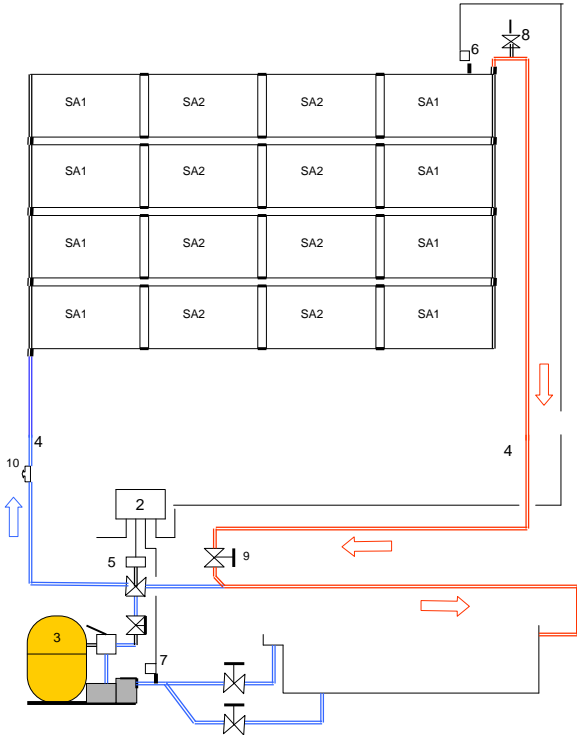

Operation with filter pump via three-way motor ball valve with difference-temperature regulation

- | | | |
|--|--------------------------------------|--------------------------------|
| 1) Sola Aqua absorber | 5) Three-way motor ball valve | 9) Stop cock (downdraft brake) |
| 2) Difference-temperature regulator OE 1 | 6) Temperature sensor, absorbers | 10) Drain cock |
| 3) Filter installation | 7) Temperature sensor, swimming pool | 11) Pump for solar circuit |
| 4) Solar circuit forward and return | 8) Vent valve | 12) Non-return valve |

Installation of the system

1. Sola-Aqua Absorbers are supplied with connecting pieces that are opened diagonally. If further connections are required to connect the absorbers in series only the cap has to be cut off.

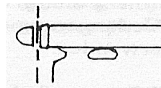

2. Place the Sola-Aqua Absorbers on the designated areas in the arrangement that is desired and connect them with hose connections and hose saddles according with the scheme of connection. In case of steeper sloping roofs roof fastenings must be carried out simultaneously to prevent absorbers from slipping away during installation.



3. To make circuit points for supply and return fuel lines. Glue the hose nozzle into the elbow or the socket and add it with the hose coupling on the absorber. If you take a pipe dia. 50 mm or bigger you have to glue a reducing.



4. Vent valve (8): The vent valve must be installed vertically. Glue in connection correspondingly and screw in vent valve.



5. Install 3-way valve (5) behind filter pump (3).

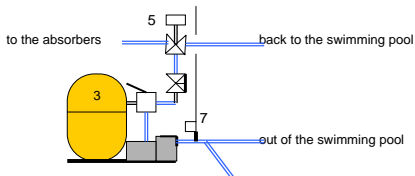

6. Put tee for collector forerun into pipe leading to the pool. Glue Stop cock (9) - downdraft brake into forerun pipe



7. Construct and fix forerun and return travel of collector (4). If for winter a drain cock is needed glue a reducing tee with reducing piece 1/2" for the drain cock.



8. Regulation: Please take a look at the instruction for installation and operating for the difference-temperature regulation and the three-way motor ball valve respectively the pump. Attention should be paid to the accomplishment of electrical installation. Swimming pools systems have to be equipped with a earth leakage circuit breaker.

Fasten collector sensor (6) to absorber with clamp. Glue reducing tee with nipple 1/2" for swimming pool sensor (7) into pipe coming from the pool and screw in sensor. Fix the difference-temperature regulator and fasten it like the wiring diagram. Use wires with cross-section 2 x 1 mm² to lengthen sensor adaptors.



If you take a pump with more than 600 W charging rate or three-phase pumps, you have to install a contactor.

Operating Instruction

To start the system adjust the difference temperature to approx. 3 or 4 °C and place the hand switch on automatic. In systems working with filter pumps adjust the filter cycle to the hours of sunshine. Installations with own pump works independent from the filter circuit.

If after a few minutes the system works still with air in it, close the stop cock (downdraft brake) a little until the water escape at the intake nozzle is majority free of air. The stop cock now always stay this way. Additionally you can close the cover cap of the vent valve.

Operating the system in winter

Sola-Aqua Absorbers are frost resistant. Due to the pipes the system must be emptied in winter nevertheless. Usually systems which have been emptied when they're switched off, don't need any precaution.

Advice to glue pvc pipes

Glue pvc pipes only if they're absolutely dry. Water, condensates and humidity prevent a good connection.

Don't glue under a Temperature of 5°C. The time for drying is circa 24 hours, do not use it with pressure before.

Clean ends and fittings with a cleaner. Glue both parts the same way. Take a flat brush. It's important to disperse the glue lengthwise from the inside to the outside. Directly after apply the glue you have to plug ends and fittings together. Take of the surplus glue. Clean the brush with cleaner.

How to fasten on a pantiles tiled roof

1. Hook for pantiles tiled roof Part.N° SA212
2. Screw-in pipe clamp 1/2" zinc plated with a gum inlay Part.N° SA213
3. Perforated tape zinc plated 12 x 1 Part.N° SA210 with a screw 5 x 16 Part.N° SA211

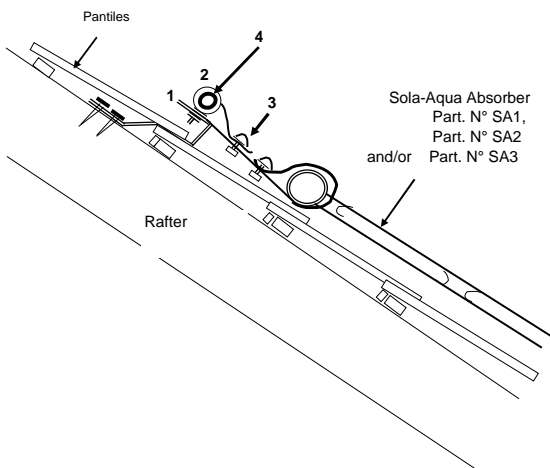
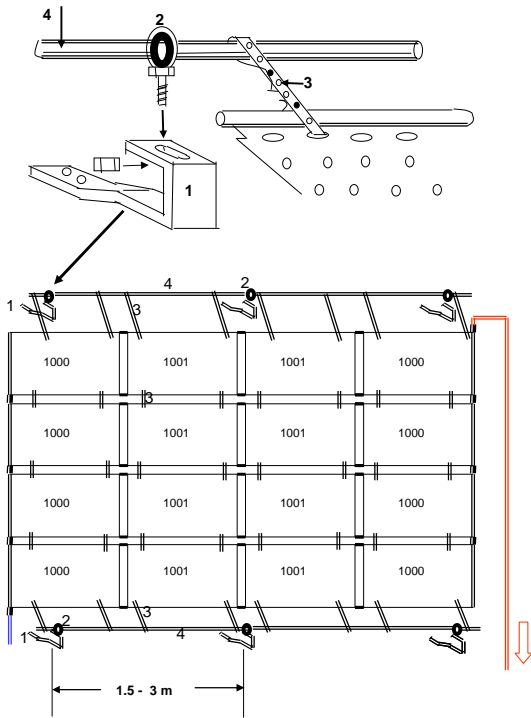

How to fasten on a flat roof

On a flat roof you have to make safe the Absorbers against the wind. Therefore you can stretch a wire rope or a perlon-hurly against the absorber field at intervals of circa 2 m and anchor it on the edge of the roof. You can also weigh the absorbers down directly or you can fasten them with garden-plates and U-profiles. Take a look at the diagram below.

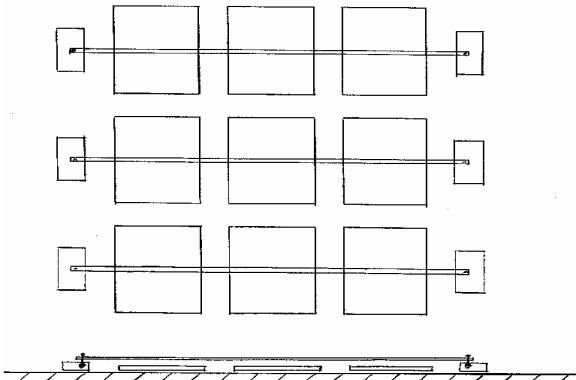

How to fasten it on a sloping roof (slated roof or cement asbestos roof)

The fastening on a slated or cement asbestos roof is comparable with the fastening on a tiled roof. But you have to screw-in the ring-screw through the roofing into the foundation. If you have a wooden foundation screw it into the boarding or battens. If you bore slate or cement asbestos you have to do it without the slugging device to get around splitting the plates. After screwing-in the screw you have to seal it up with silicone or another sealing compound like this.